

(12) **United States Design Patent**
Schmitz, III

(10) **Patent No.:** **US D481,425 S**
 (45) **Date of Patent:** **** *Oct. 28, 2003**

(54) **AIR SOURCE ADAPTER FOR A PAINT BALL GUN**

Primary Examiner—Raphael Barkai
 (74) *Attorney, Agent, or Firm*—Mathew R. P. Perrone, Jr.

(76) **Inventor:** **John E. Schmitz, III**, 351 H Brittany Ct., Geneva, IL (US) 60134

(57) **CLAIM**

The ornamental design for a air source adapter for a paint ball gun, as shown and described.

(*) **Notice:** This patent is subject to a terminal disclaimer.

(**) **Term:** **14 Years**

(21) **Appl. No.:** **29/147,025**

(22) **Filed:** **Aug. 21, 2001**

(51) **LOC (7) Cl.** **21-01**

(52) **U.S. Cl.** **D21/573**

(58) **Field of Search** D21/567-575;
 D22/101, 103-104, 107-108; D23/225,
 224, 222; 446/180, 219, 267, 430, 473,
 475; 124/80, 71-75; 273/310-311; 222/78-79

(56) **References Cited**

U.S. PATENT DOCUMENTS

D353,853 S	*	12/1994	Albritton	
5,503,137 A	*	4/1996	Fusco	124/72
5,896,850 A	*	4/1999	Sullivan, Jr.	124/74
6,138,656 A	*	10/2000	Rice et al.	124/73
D440,262 S	*	4/2001	Fernandez et al.	D21/570
6,273,080 B1	*	8/2001	Sullivan, Jr.	124/84
6,367,465 B1	*	4/2002	Bucciari, Jr.	124/31
6,371,099 B1	*	4/2002	Lee	124/66

* cited by examiner

DESCRIPTION

FIG. 1 is a perspective view of an air source adapter for a paint ball gun of my invention in use on a paint ball gun shown in phantom;

FIG. 2 is a top plan view of the air source adapter for a paint ball gun;

FIG. 3 is a bottom plan view thereof, based on FIG. 2;

FIG. 4 is a side view of the air source adapter for a paint ball gun of this invention, based on FIG. 3;

FIG. 5 is a top perspective view of the air source adapter for a paint ball gun of this invention, based on FIG. 2;

FIG. 6 is a top perspective view of the air source adapter for a paint ball gun of this invention, rotated slightly to the right and based on FIG. 5;

FIG. 7 is a bottom perspective view of the air source adapter for a paint ball gun of this invention, based on FIG. 3 having a slight downward rotation; and,

FIG. 8 is a bottom perspective view of the air source adapter for a paint ball gun of this invention, based on FIG. 3 having a slight upward rotation.

The broken lines shown in FIG. 1 are for illustrative purposes only and form no part of the claimed design.

1 Claim, 2 Drawing Sheets

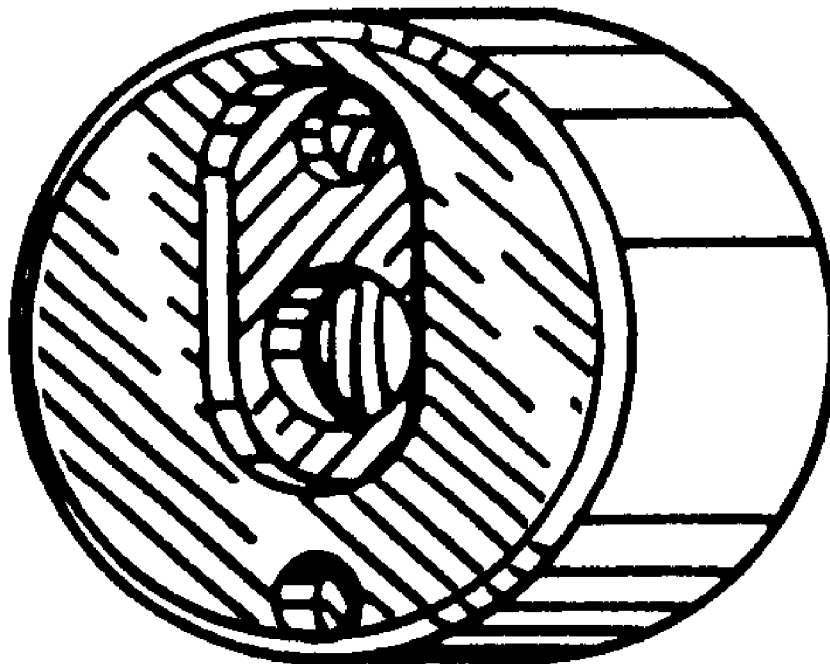

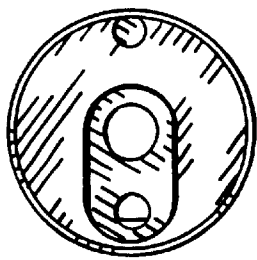
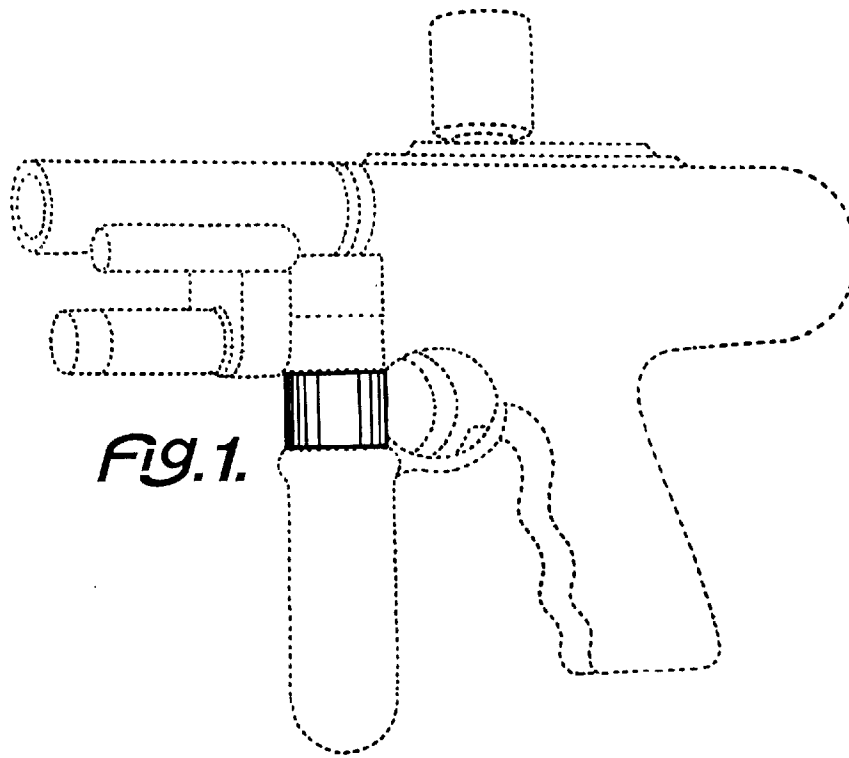

Fig. 2.

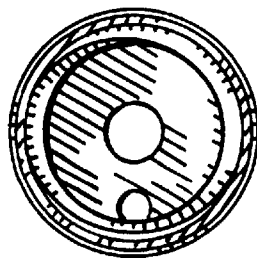

Fig. 3.

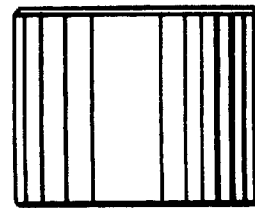

Fig. 4.

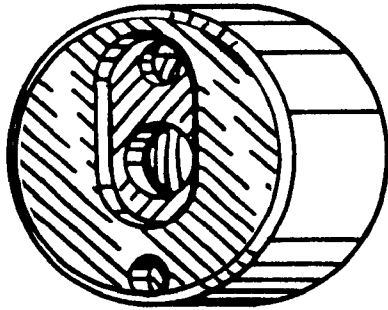

FIG. 5.

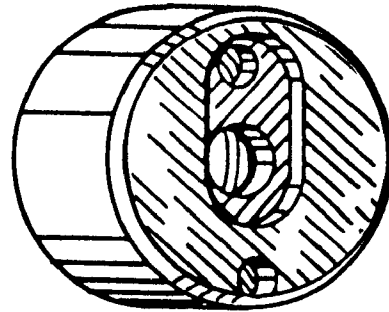

FIG. 6.

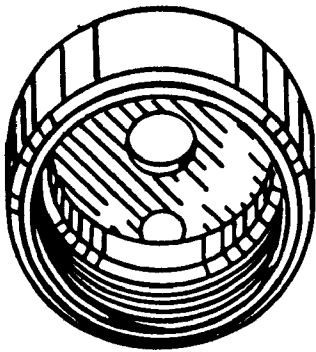

FIG. 7.

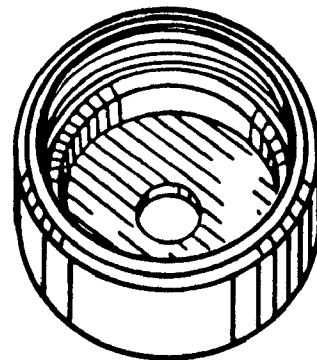

FIG. 8.